

NOTICE DE MONTAGE

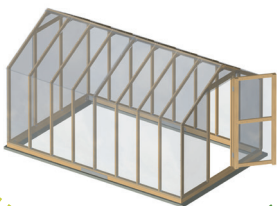

Serre
Cléopée



8H - 12H
DE MONTAGE



2 PERSONNES
MINIMUM

VOTRE KIT



Vis tête Fraisée 4 x 25 TF
4 x 50 TF



Vis tête Ronde 4 x 25 TR
5 x 35 TR



Vis tête Hexagonale 6 x 60 TH
8 x 35 TH
8 x 60 TH

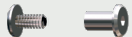

Vis tête Plate M6 x 16 + Ecrou relieur



Vis tête Plate M6 x 20 + Rondelle EPDM



Vis Bois + Rondelle EPDM

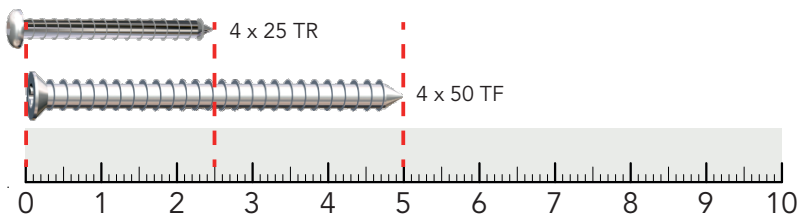
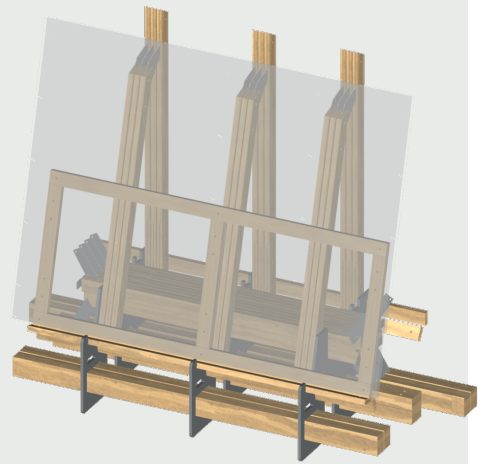

OUTILLAGE NÉCESSAIRE



Embout hexagonal 13 mm



Embout hexagonal 10 mm



Embout T20



Embout hexagonal 5 mm



Embout hexagonal 4 mm



Foret béton - Ø 8 mm



Foret bois - Ø 6 mm





Foret bois - Ø 10 mm

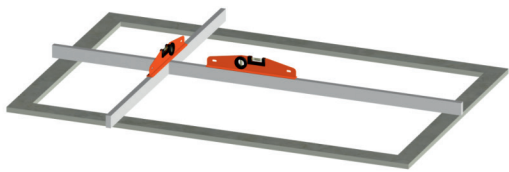

01 OK



 x 12
8 x 35 TH

 x 20
5 x 35 TR

x 2

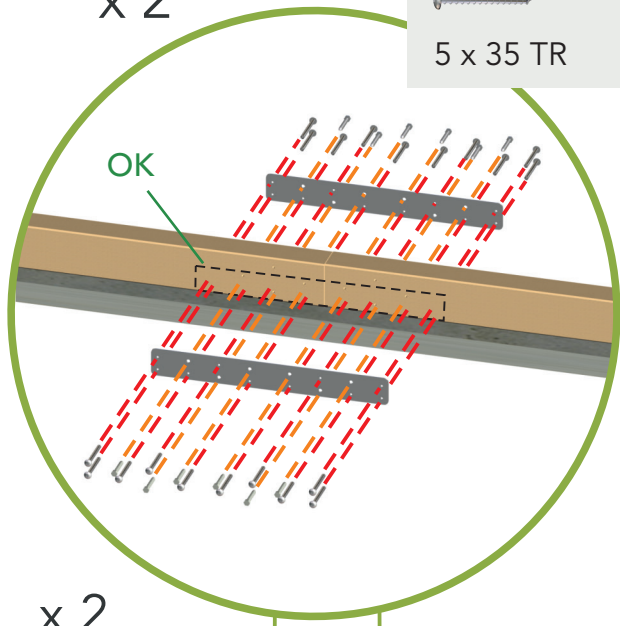

x 4

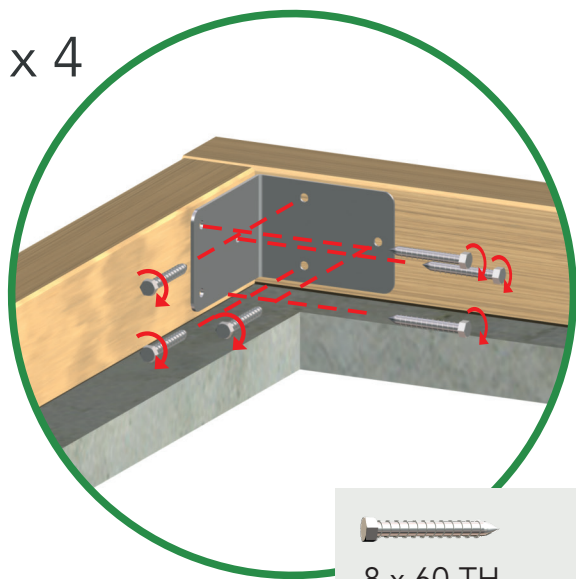

 x 6
8 x 60 TH

x 2

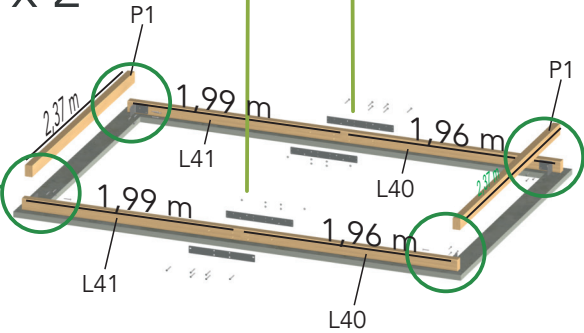

02

03 D1 = D2

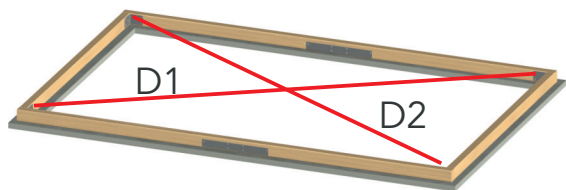

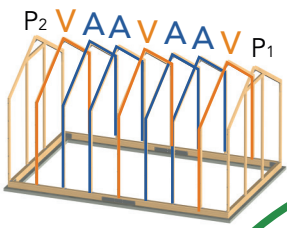

4 et 4V

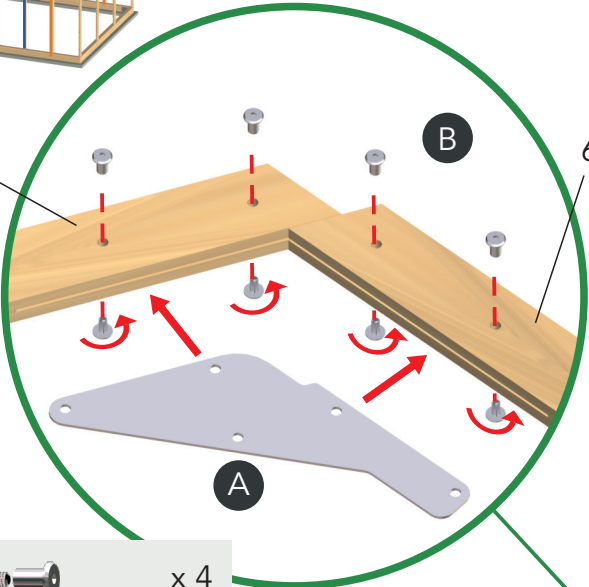

B

A

6

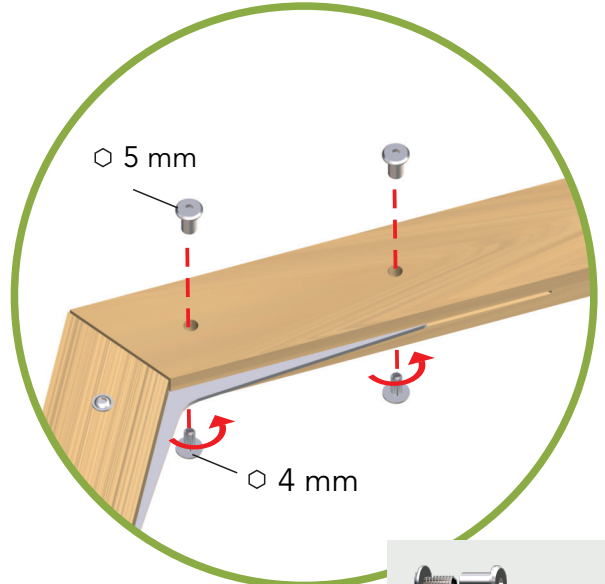

○ 5 mm

○ 4 mm

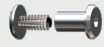
 x 2
 M6 x 16 ○ 4 mm
 ○ 5 mm

 x 4
 M6 x 16 ○ 4 mm
 ○ 5 mm

4 et 4V

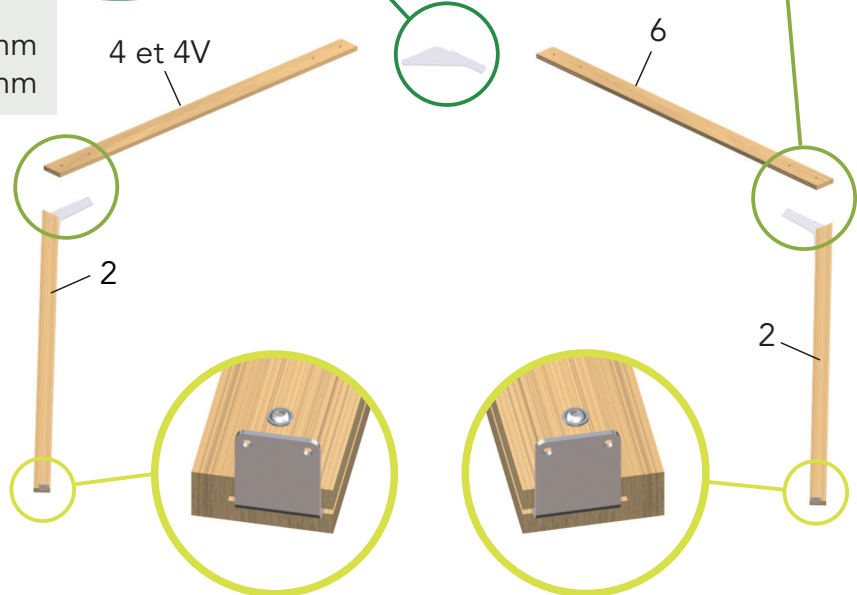

2

2

04

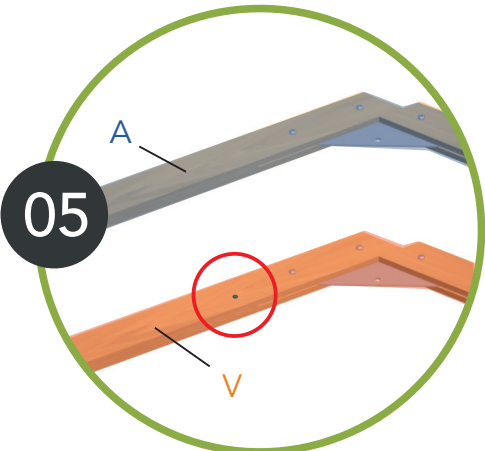

A

05

V

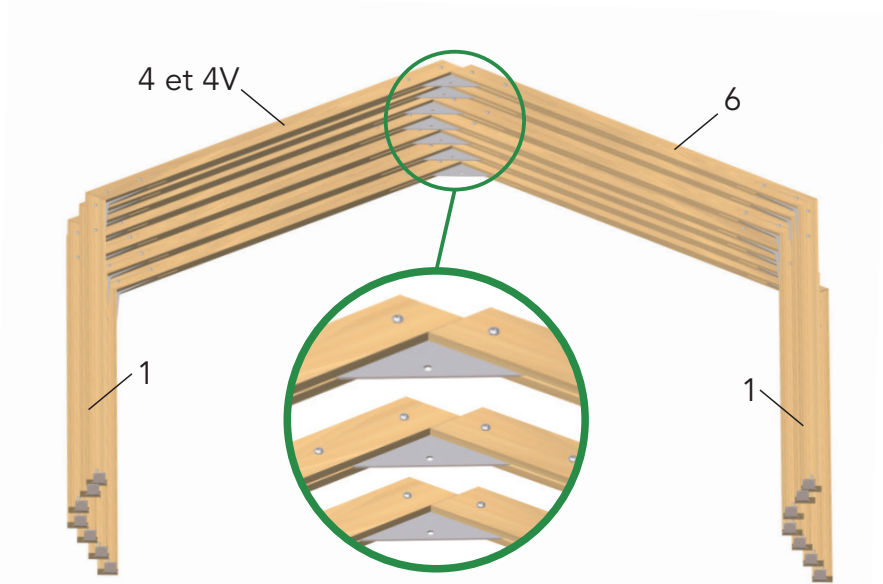

4 et 4V

6

1

1

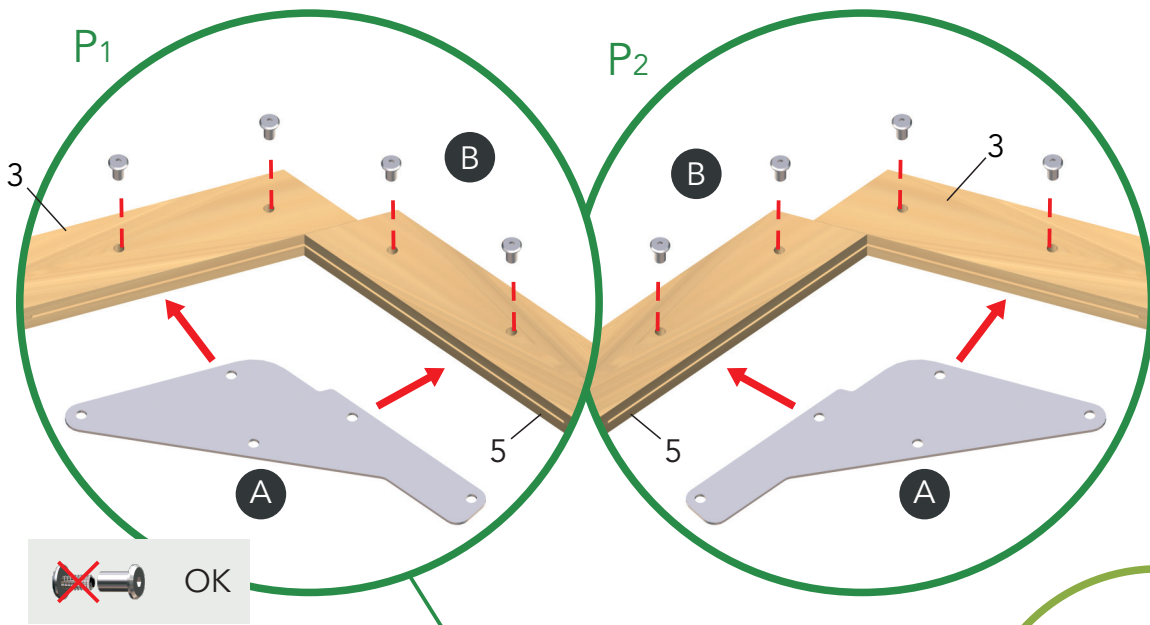
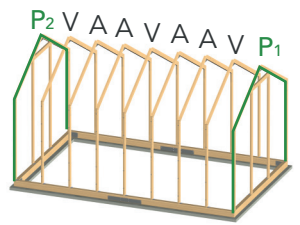

06

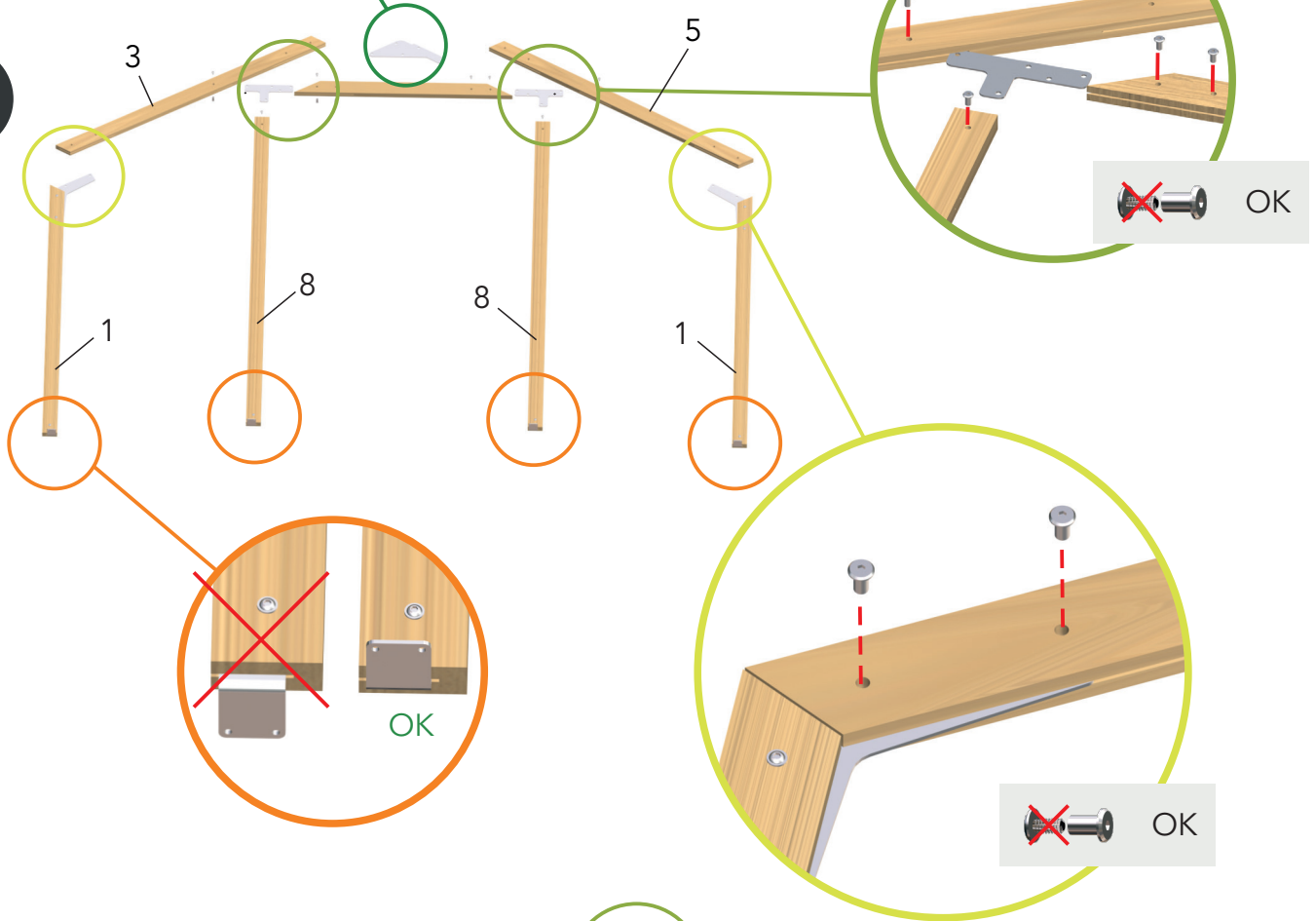

07

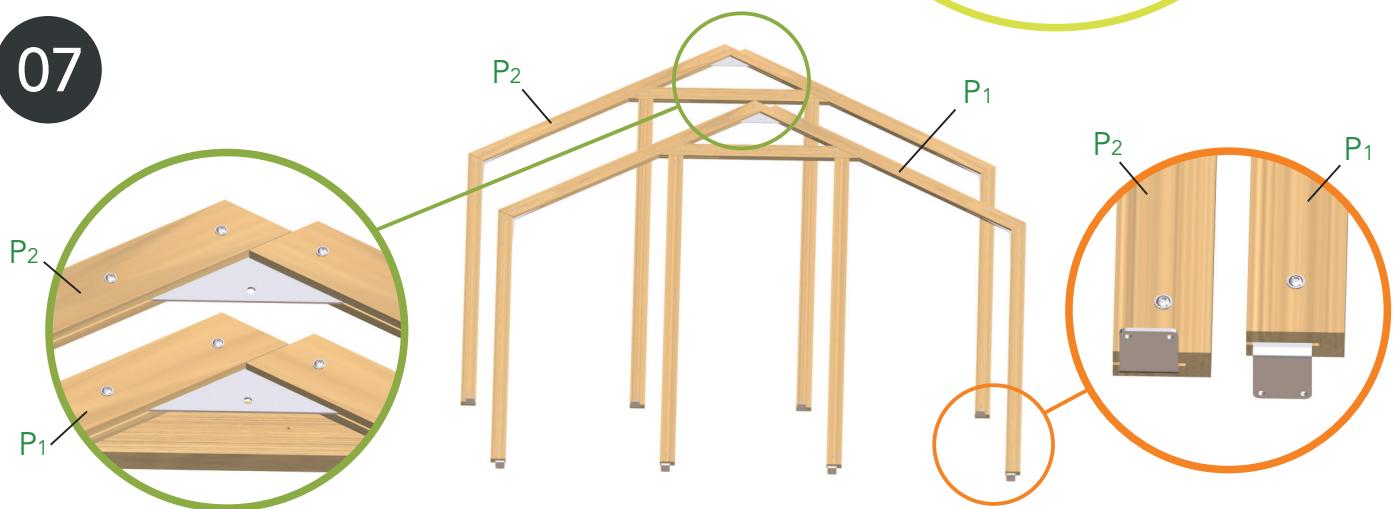

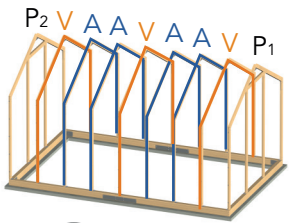

4,5 x 25

NE PAS SERRER !

08

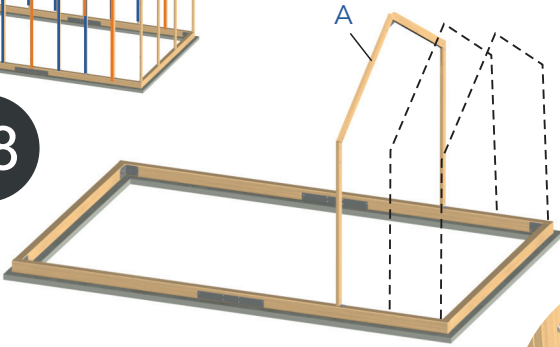

09

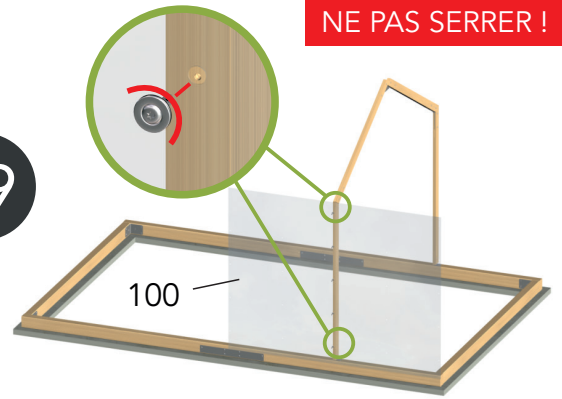

10

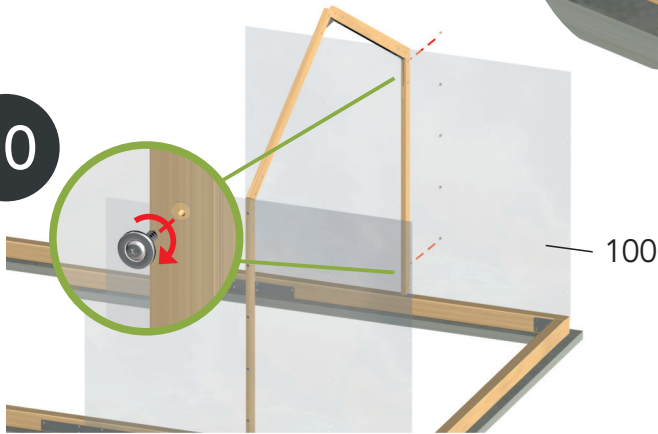

11

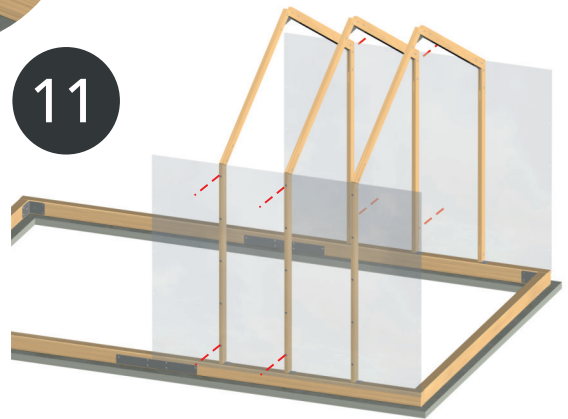

12

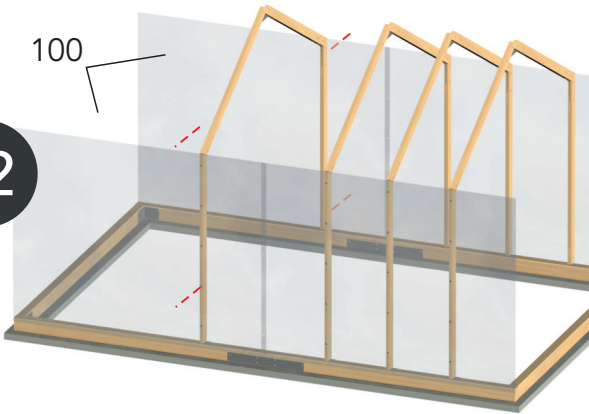

13

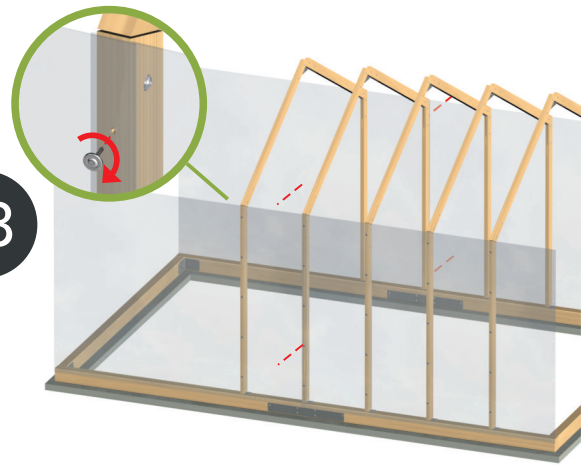

14

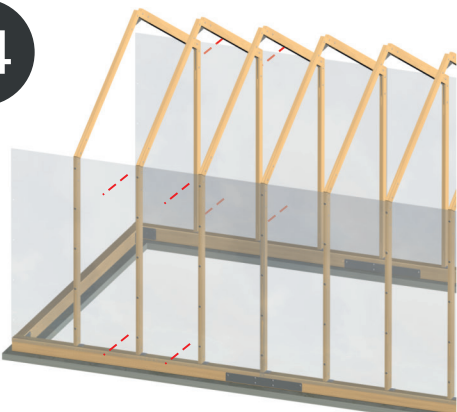

15

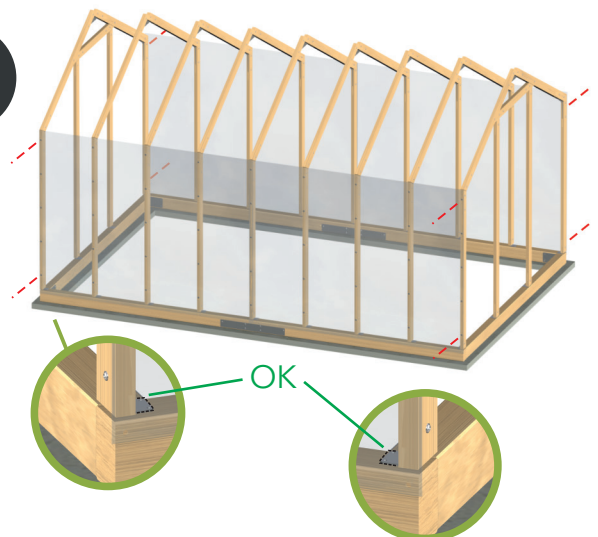

16



4,5 x 25 ☆

VISSER ET SERRER
TOUTES LES VIS

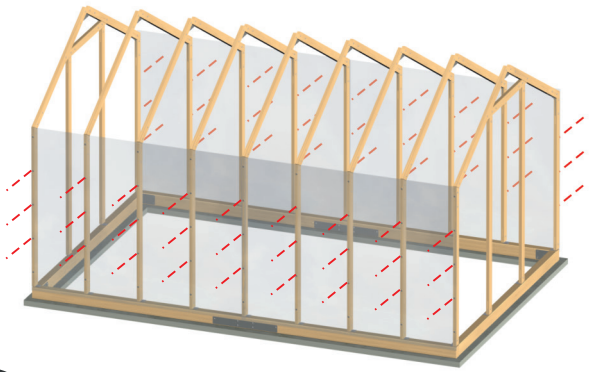

17

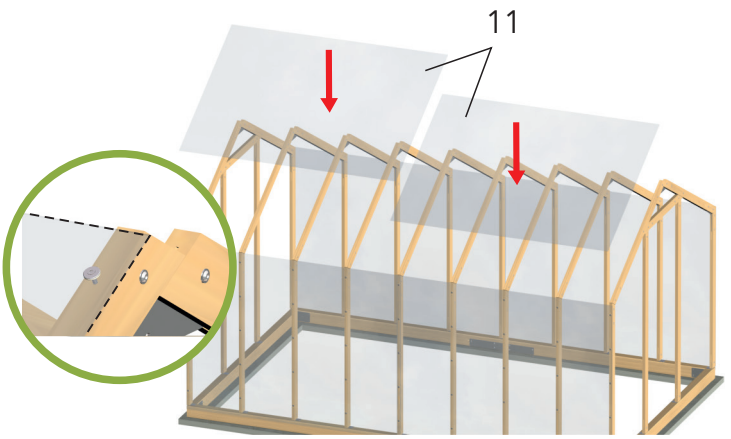

18

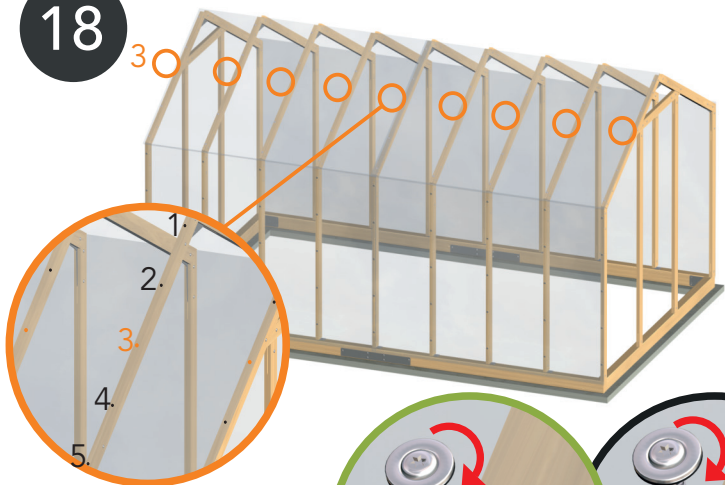

19

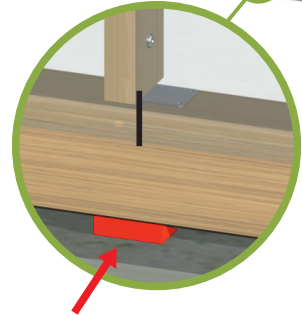
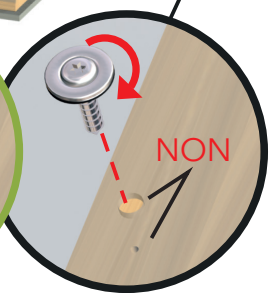
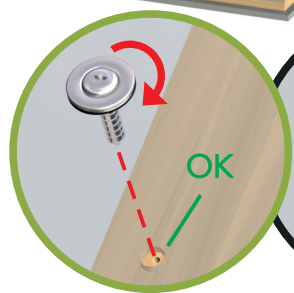
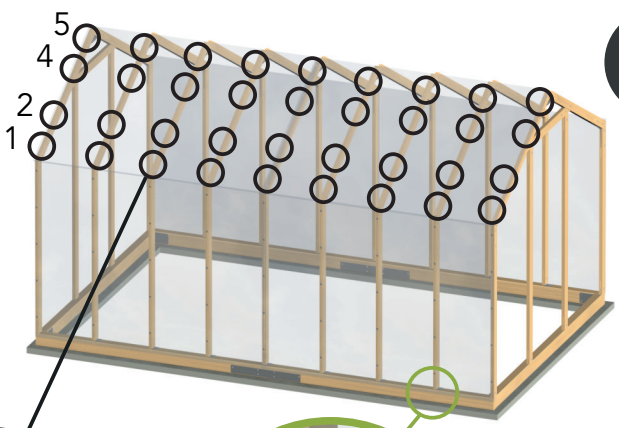

CALER SI
NÉCESSAIRE

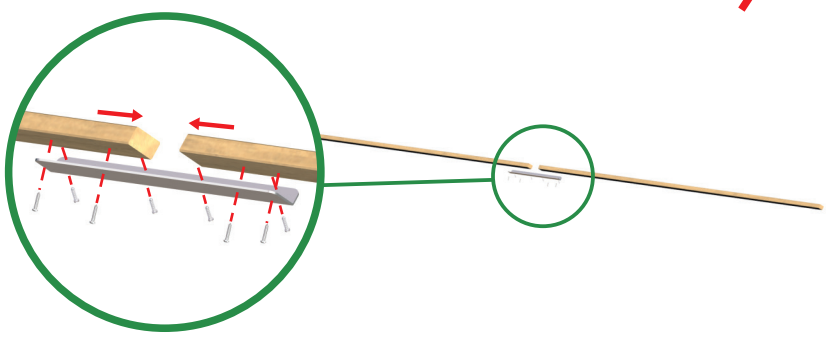

20



4 x 25 TR

21



4,5 x 25 ☆

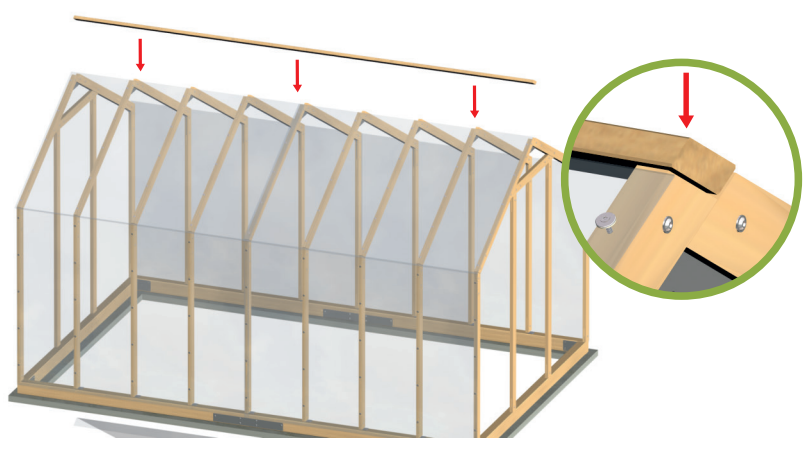

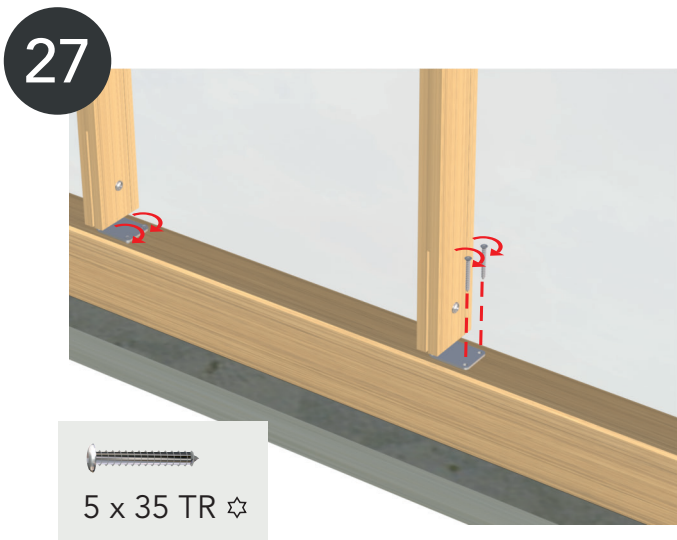
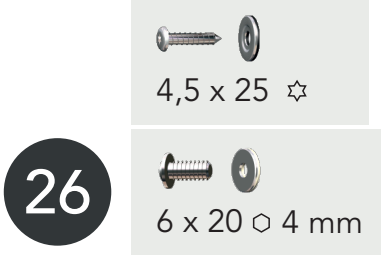
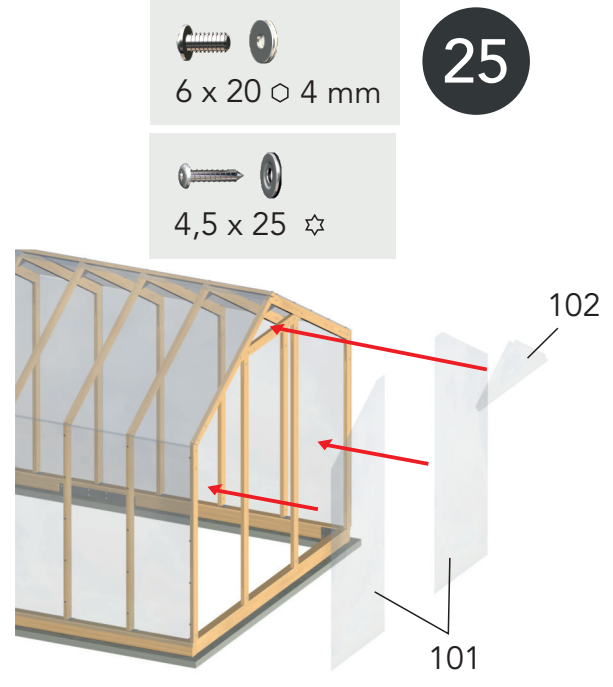
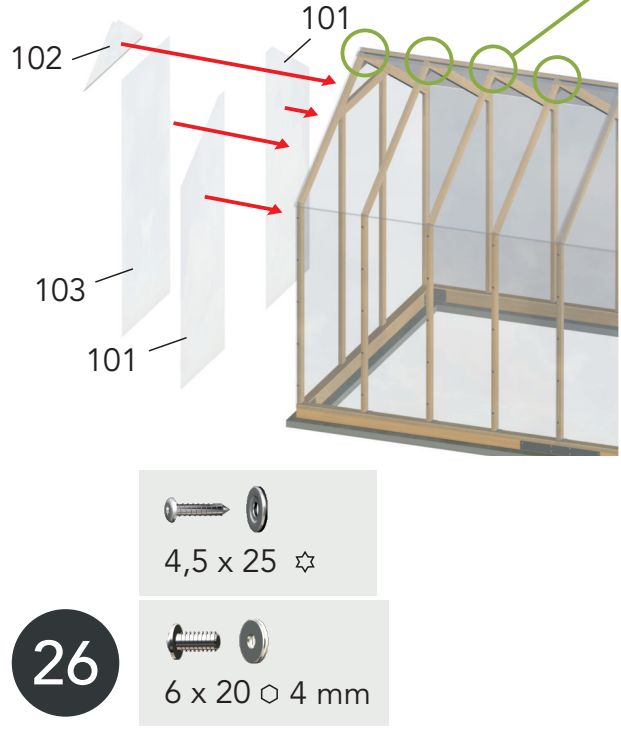
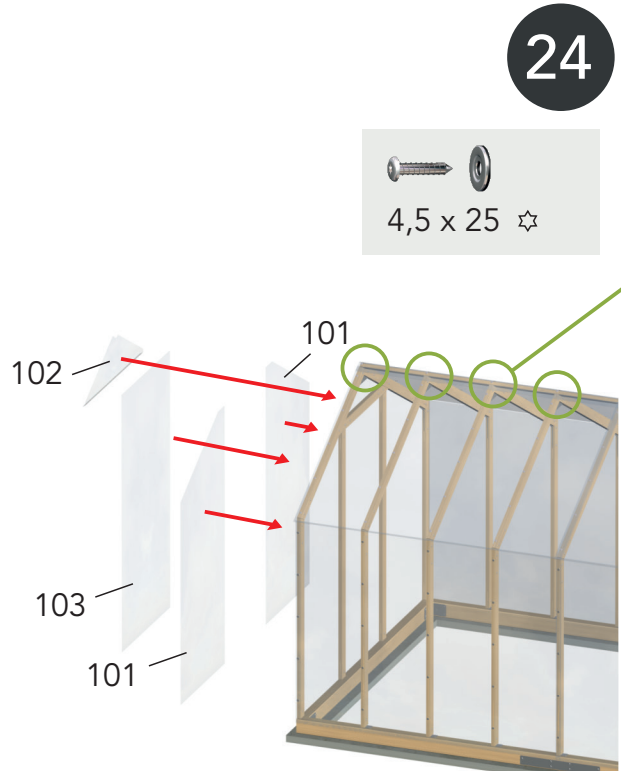
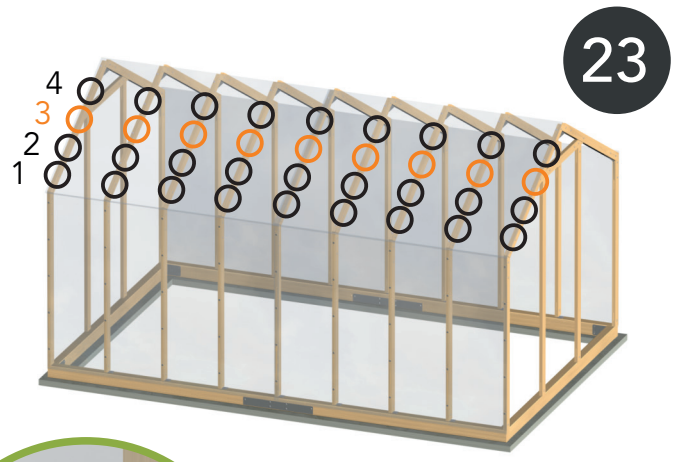
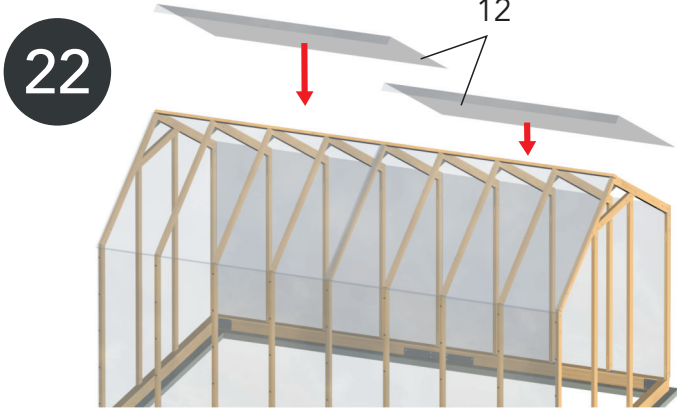

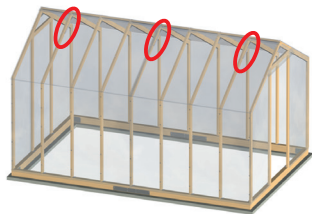

01

MONTAGE DES VÉRINS

02

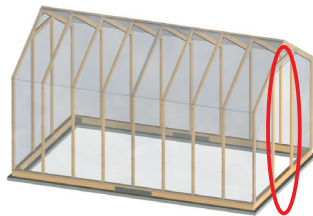
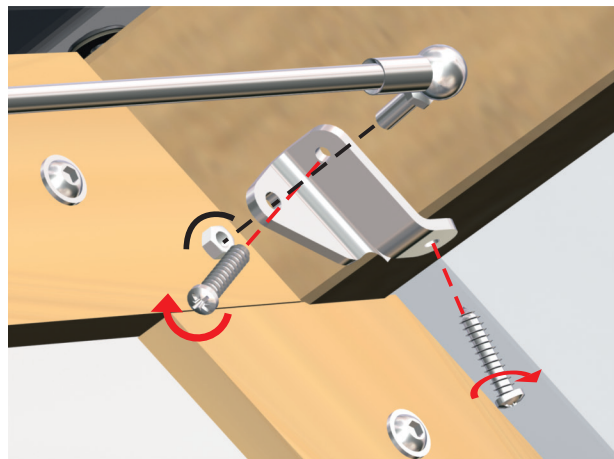
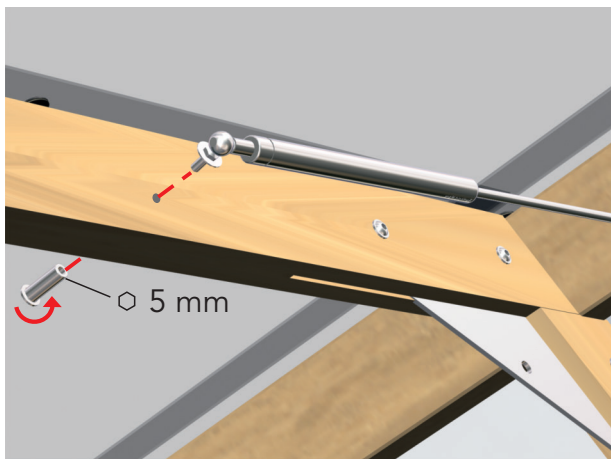

01

POSE DE LA PORTE

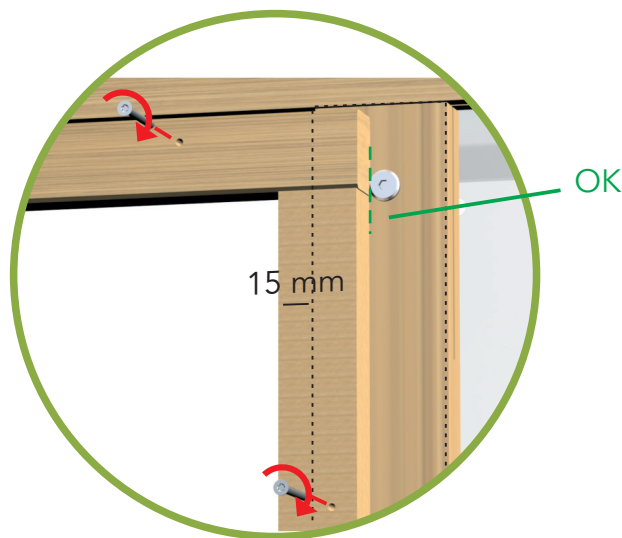
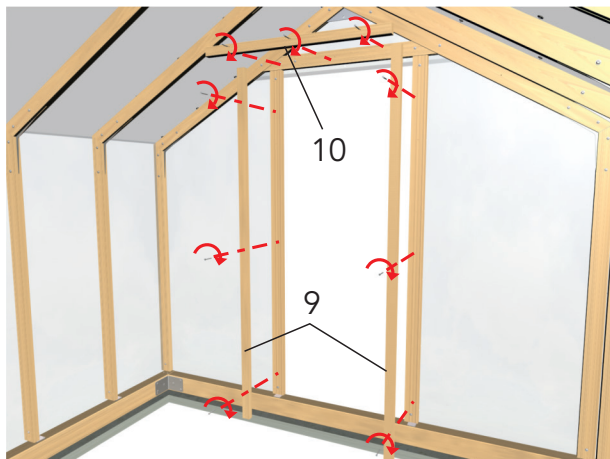

02

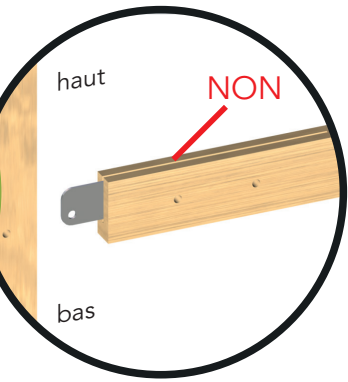
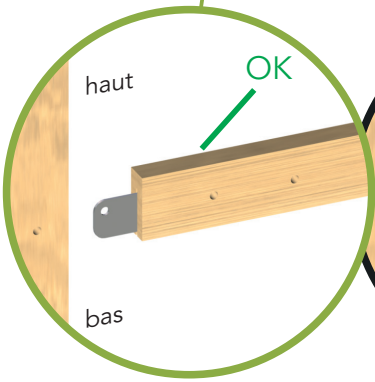
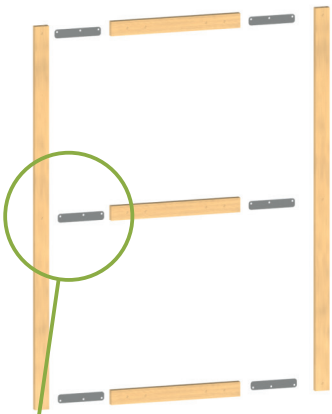

03

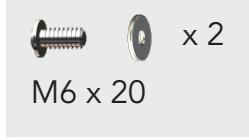
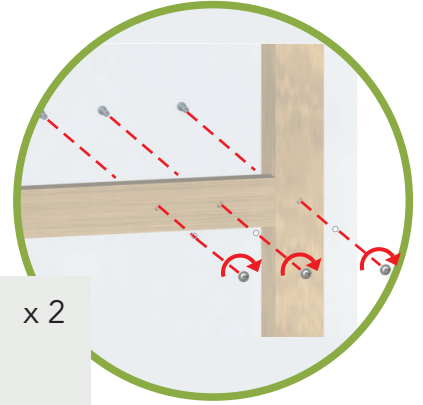
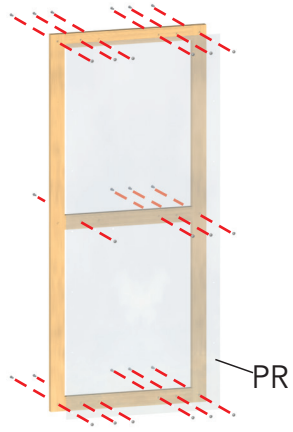

04

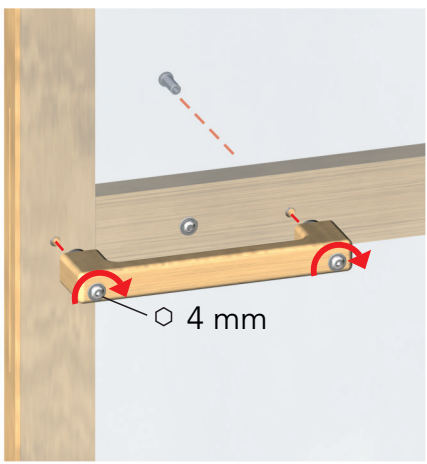

05

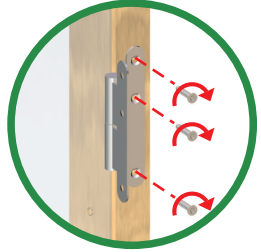

06

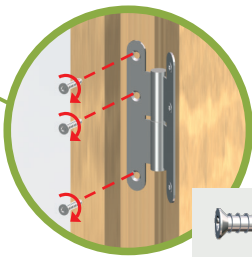
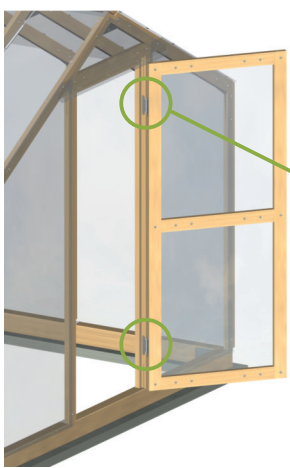

07

 x 4
4 x 25 TF ☆

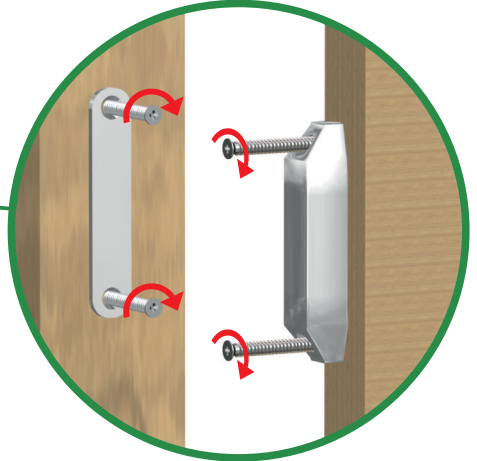
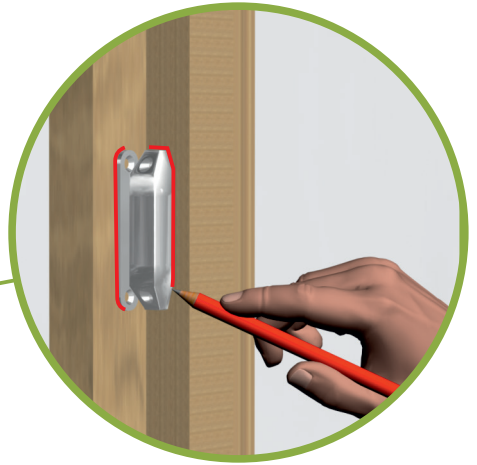
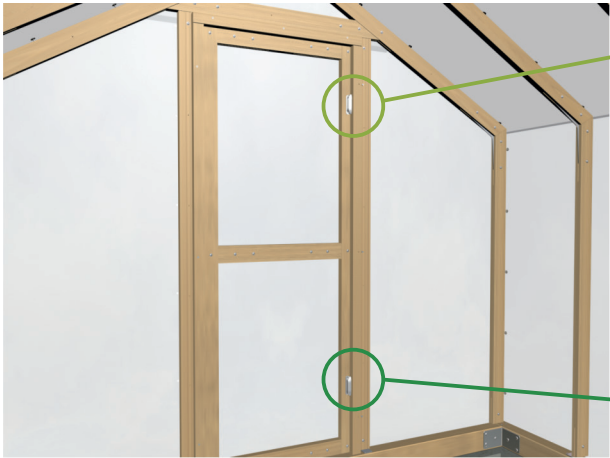

08

 bois Ø 6 mm

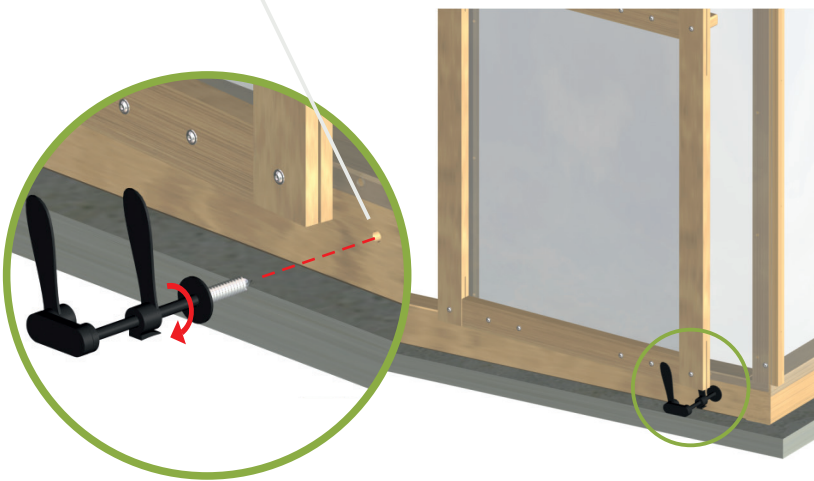

09

 x 6
4 x 25 TR

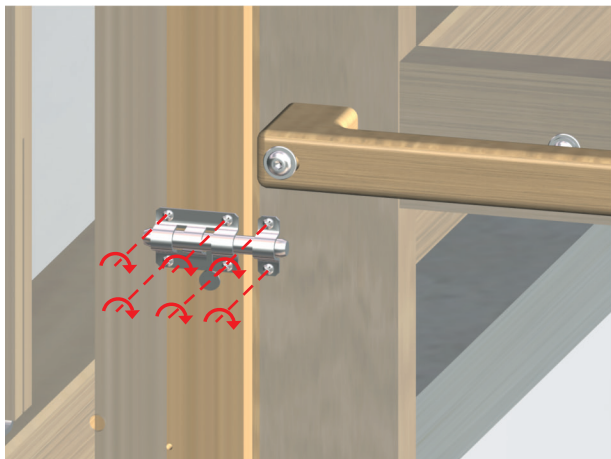

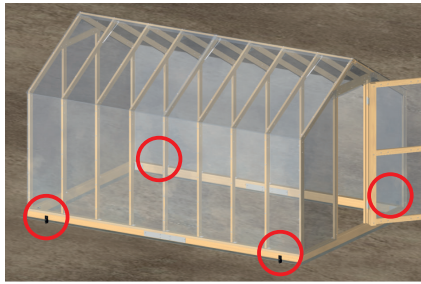

ANCORAGE

1a



CÔTÉ INTÉRIEUR
OU EXTÉRIEUR

2a

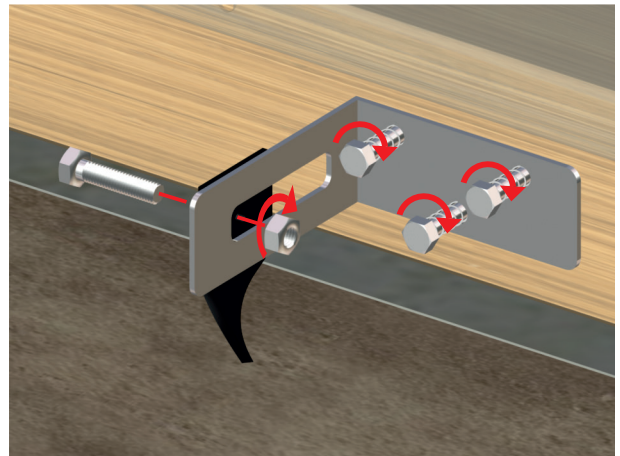

 x 3
6 x 60 TH 

1b

 bois Ø 10 mm

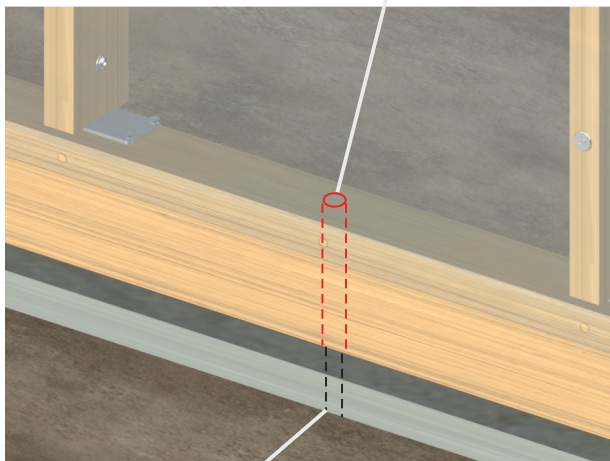

 béton Ø 8 mm

2b

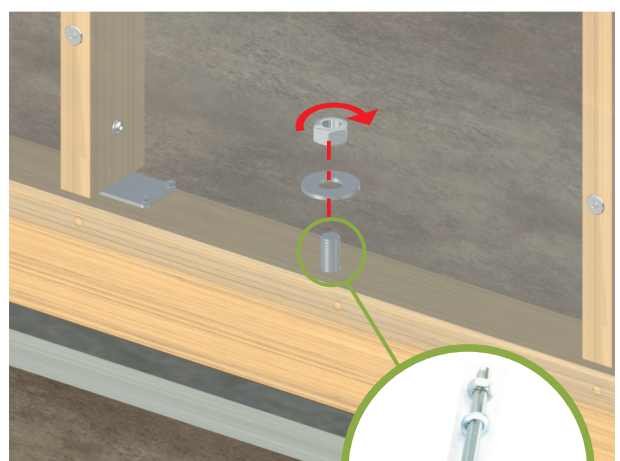

Préparation du sol : recommandations.

Quelle que soit la préparation choisie, il est indispensable de préparer une surface plane afin de poser la serre, et ce surtout pour les serres les plus grandes. L'emploi d'un niveau laser est vivement recommandé.

Voici 3 alternatives recommandées avant de poser la serre/

1. graviers

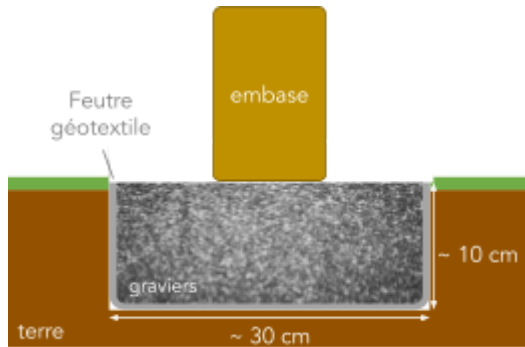

L'emploi de gravillons permettra de drainer l'eau et de faciliter l'aplanissement de la surface.

L'utilisation d'un feutre géotextile isolera les graviers et évite la pousse d'herbe à travers les graviers et contre l'embase de la serre

2. plots

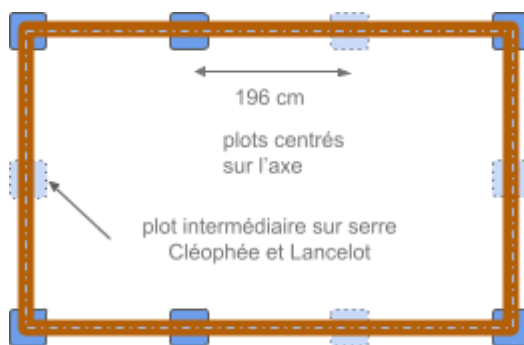

Des plots bétons, par exemple regards de 30x30 cm remplis de béton, est une bonne alternative permettant de créer des points d'ancrages solides et stables. Les regards seront à centrer sur l'axe de l'embase, et la hauteur de tous les plots doit être identique (différence < 1 cm)

Sur la longueur de la serre, les espacer régulièrement tous les 2m.

3. longrine

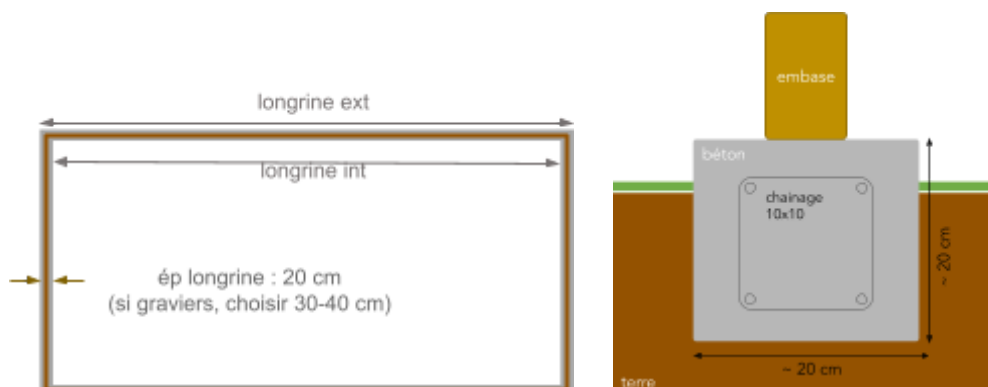

La réalisation d'une longrine présente (ou d'une dalle sur toute la surface) est le choix le plus indiqué pour faciliter la pose et réaliser un ancrage durable

Dimensions du support

Ce tableau vous aidera à préparer le sol en fonction des dimensions de la serre. L'exemple est proposé pour une longrine de 20 cm de d'épaisseur, ce qui donne une différence totale de 40 cm entre la côte intérieure et la côte extérieure de la longrine (car l'épaisseur est de 20 cm de chaque côté de la serre).

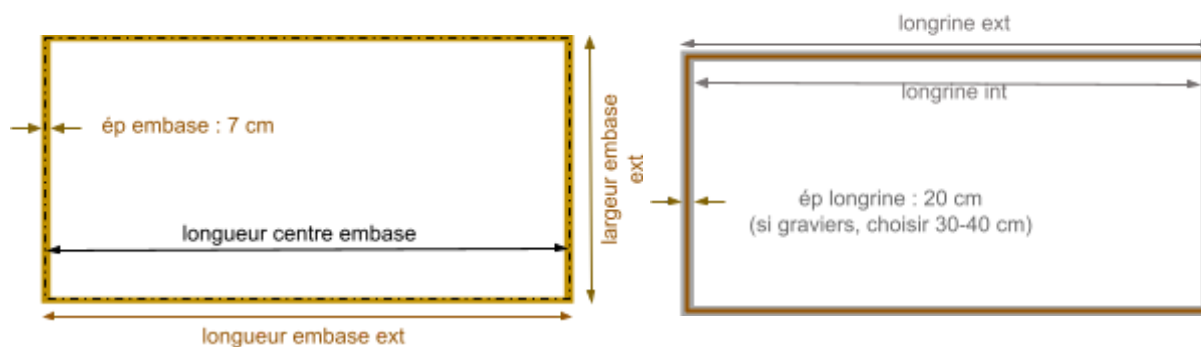

	largeur ext embase (mm)	largeur int embase (mm)	largeur axe embase (mm)	largeur intérieure longrine (cm)	largeur extérieure longrine (cm)
Ulysse	1986	1846	1916	172	212
Cléopée	2513	2373	2443	224	264
Lancelot	3380	3240	3310	311	351

longueur arrondie (m)	longueur exacte embase (mm)	longueur int embase (mm)	longueur axe embase (mm)	longueur intérieure longrine (cm)	longueur extérieure longrine (cm)
2	1988	1848	1918	172	212
3	2968	2828	2898	270	310
4	3948	3808	3878	368	408
6	5908	5768	5838	564	604
8	7868	7728	7798	760	800
10	9828	9688	9758	956	996
12	11788	11648	11718	1152	1192
14	13748	13608	13678	1348	1388
16	15708	15568	15638	1544	1584
18	17668	17528	17598	1740	1780
20	19628	19488	19558	1936	1976
22	21588	21448	21518	2132	2172
24	23548	23408	23478	2328	2368

Dimensions de la serre : diagonales

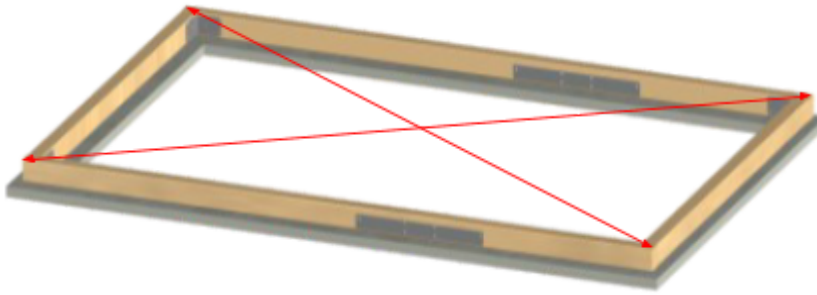

DIAGONALE		Ulysse			Cléopée	Lancelot
		longueur ext embase (mm)	1986	2513	3380	
longueur serre (m)	longueur exacte (mm)					
1,5	1498		2488	2926	3697	
2	1988		2810	3204	3921	
3	2968		3571	3889	4498	
4	3948		4419	4680	5197	
6	5908		6233	6420	6807	
8	7868		8115	8260	8563	
10	9828		10027	10144	10393	
12	11788		11954	12053	12263	
14	13748		13891	13976	14157	
16	15708		15833	15908	16068	
18	17668		17779	17846	17988	
20	19628		19728	19788	19917	
22	21588		21679	21734	21851	
24	23548		23632	23682	23789	

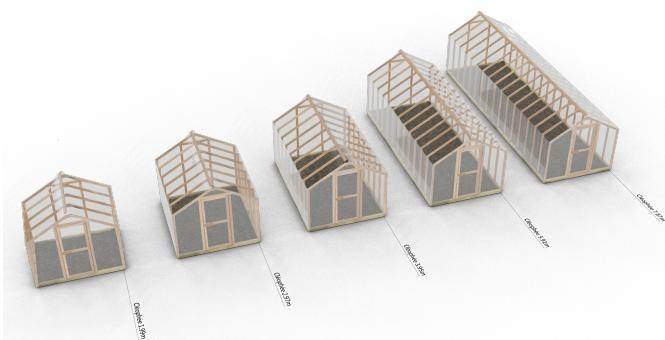
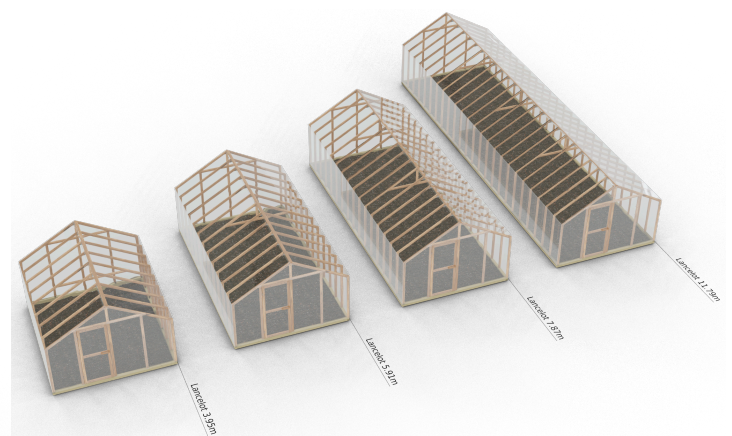
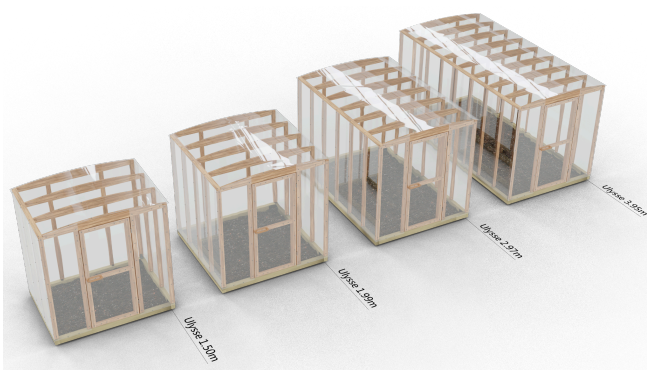

Repérage et cadencement des charpentes

P (Pignon) : La première et la dernière, elles doivent être symétrique (encoche pour la faitière dans le même sens, et pattes orientées vers l'intérieur de la serre)



A (Arbalétrier) : Ce sont des charpentes intermédiaires

E (Entrait) : Sur les longs modèles Cléopée et Lancelot, certaines charpentes sont renforcées d'un entrain

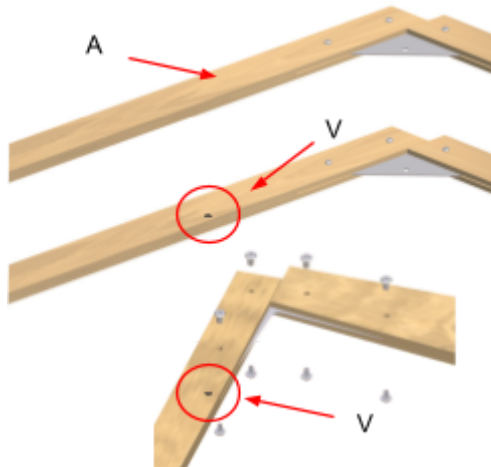

V (Vérin) : Elles disposent d'un perçage destiné à recevoir le vérin d'ouverture de la faitière.

Note : les charpentes (EV) sont renforcées et destinées à recevoir le vérin.

long	nb renfort T	nb vérin	organisation charpentes	nb PC Ulysse (mur et toit) par côté	nb PC 2m (mur Cléo, Lan) 100 11 et 12	nb PC 1,5m (toit Lancelot) 21 et 22
1,5 m		2	PVVP	1x 1,5m		
2 m		2	PVAVP	1x 2m	1	
3 m		2	PVAAAVP	2x 1,5m	1 + 1m	
4 m		3	PVAAVAVP	2x 2m	2	2 + 1m
6 m	1	4	PVAAVAEVAVP		3	4
8 m	2	5	PVAAVEAAVAVP		4	5 + 0,5m
10 m	2	6	PVAAVAEVAAVAVP			6 + 1m
12 m	2	7	PVAAVAAA(EV)AAVAAA(EV)AAVAVP			8
14 m	3	8	PVAAVAAEVAAVAAVAVP			9 + 0,5m
16 m	3	9	PVAAVAAA(EV)AAVAAA(EV)AAVAVP			10 + 1m
18 m	4	10	PVAAVAAEVAAVAAVAVP			12